

ALKALINE-MANGANESE DIOXIDE BATTERY

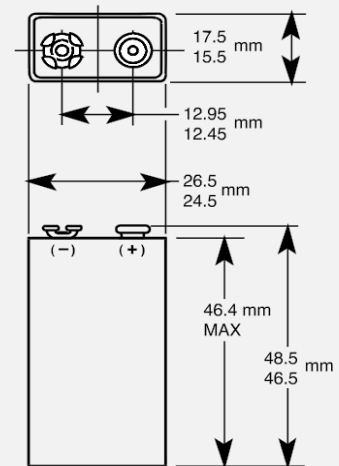

size: 9V (6LR61) PC1604



Dimensions shown are IEC standards

KEY FEATURES

- Reliable Performance
- Excellent resistance to corrosion
- Designed to meet all major quality, safety and environmental standards:
 - Safety: IEC 60086-5
 - ANSI C 18.1M, Part-2
 - EU Battery Directive
 - Quality: ISO 14001 and 9001, Duracell World Class Continuous Improvement Program

TYPICAL APPLICATIONS

- Carbon Monoxide Detectors
- Smoke Detectors
- Multimeters
- Medical Devices
- Microphones

ELECTRICAL CHARACTERISTICS

- | | |
|---|----------|
| ▪ Nominal capacity (2 mA Cont., 5V cut-off) | 673 mAh |
| ▪ Typical Voltage (at + 20 °C) | 9 V |
| ▪ AC Impedance @ 1kHz | 1,700 mΩ |

PHYSICAL CHARACTERISTICS

- | | |
|------------------|---|
| ▪ Typical weight | 45.0 g (1.6 oz) |
| ▪ Typical volume | 22.8 cm ³ (1.4 in ³) |
| ▪ Terminals | Miniature snap |

OPERATING & STORAGE CONDITIONS

- | | |
|--|----------------------------------|
| ▪ Operating temperature range | -20°C to 54°C (-4°F to 130°F) |
| ▪ Recommended Storage (storage area should be clean, cool, dry and ventilated) | 5°C to 30°C (41°F to 86°F) |

TYPICAL PERFORMANCE

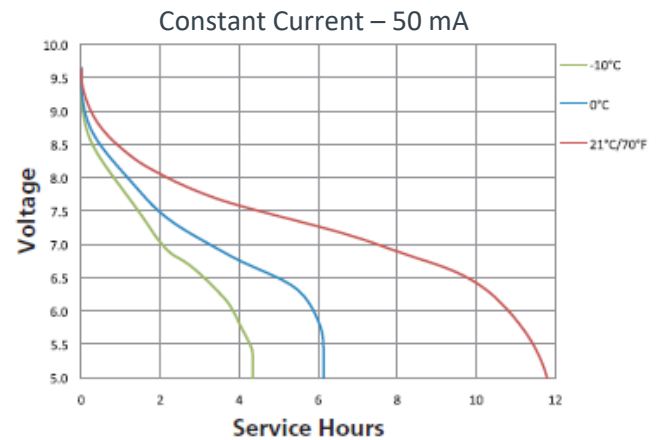
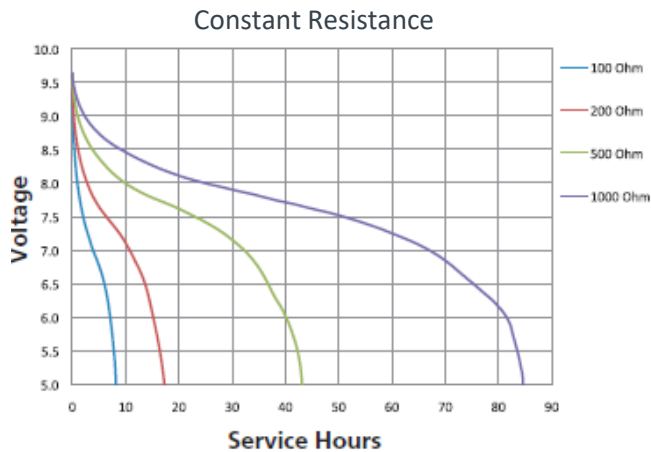
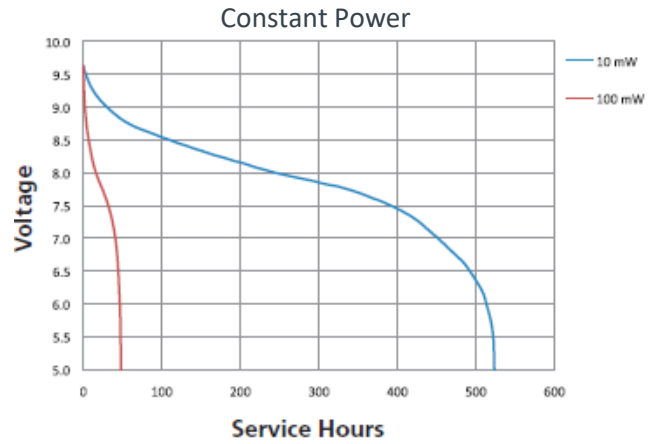
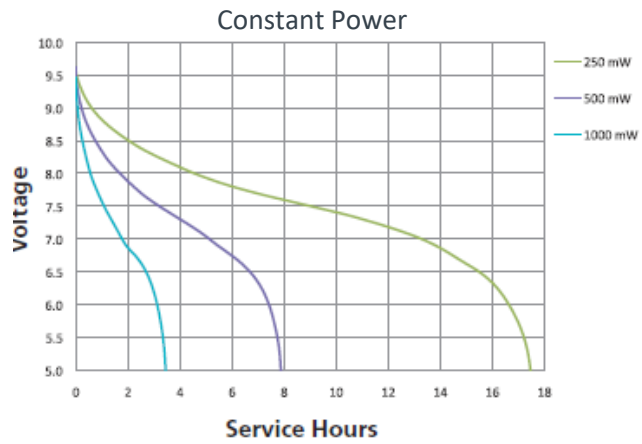
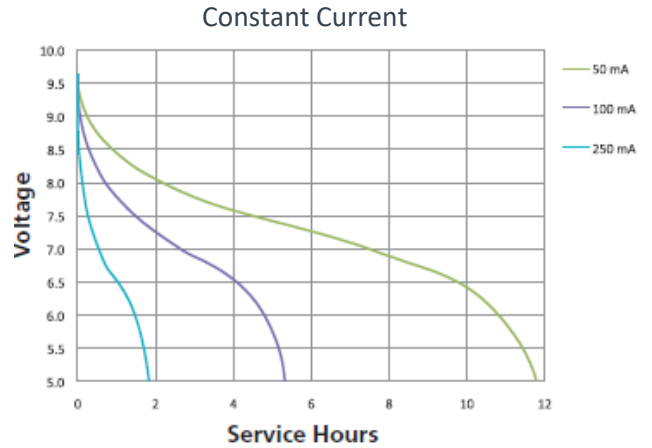
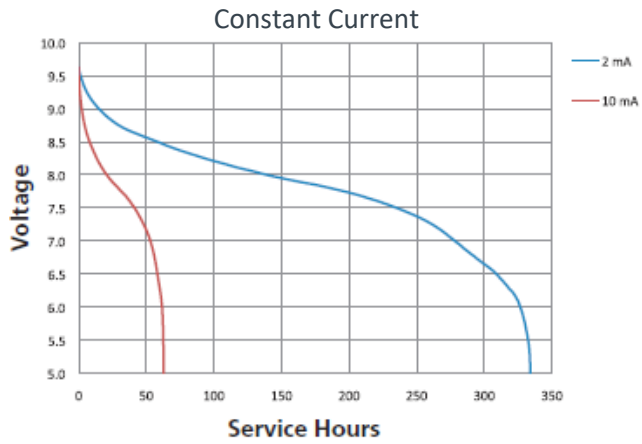

Delivered capacity is dependent on the applied load, operating temperature and cut-off voltage. Please refer to the charts and discharge data shown for examples of the energy/service life that the battery will provide for various load conditions.

This data is subject to change. Performance information is typical. Contact Duracell for the latest information.